

Orientacija stanovanja

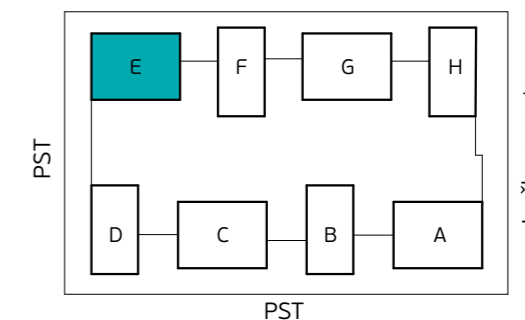

Skica naselja

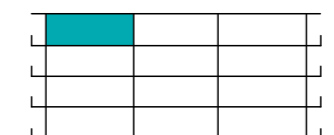

Položaj stanovanja v stavbi - prerez



Položaj stanovanja v nadstropju - tloris

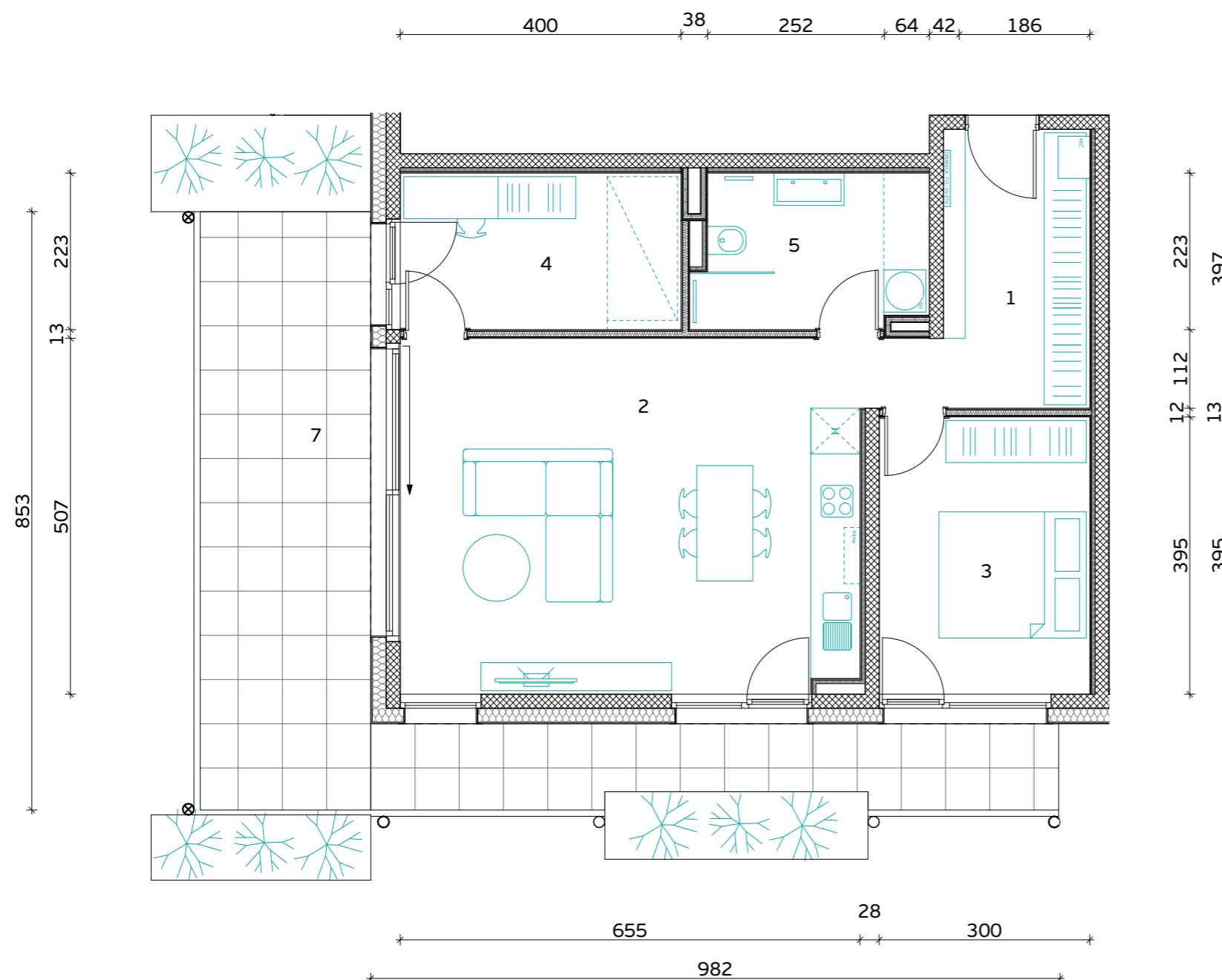

STAVBA "E" - 3. NADSTROPJE

STANOVANJE E-3-3

1. PREDPROSTOR	8.3 m ²
2. BIVALNI PROSTOR	34.2 m ²
3. SPALNICA	11.8 m ²
4. KABINET	8.9 m ²
5. KOPALNICA	6.7 m ²

STANOVANJSKA POVRŠINA **69.9 m²**

7. TERASA (NADKRITA)	31.3 m ²
8. SHRAMBA ZA KOLESA	4.3 m ²

SKUPNA POVRŠINA **105.5 m²**

PARKIRNO MESTO 1 PM

VIŠEČI VRTOVI 11.0 m²



PRVAHIŠA

Družba za razvoj nepremičninskih projektov

INVESTITOR: **JURČKOVO NASELJE d.o.o.**

PRODAJALEC: **PRVA HIŠA d.o.o.**

Bravničarjeva ulica 13, 1000 Ljubljana

+386 (0)1 292 65 00

info@prvahisa.si

www.jurckovo-naselje.si

Komercialna skica in vrisana stanovanjska oprema sta informativne narave. Investitor si pridržuje pravico do sprememb, ki ne vplivajo na funkcionalnost stanovanj.

MERILO

