

MERILO

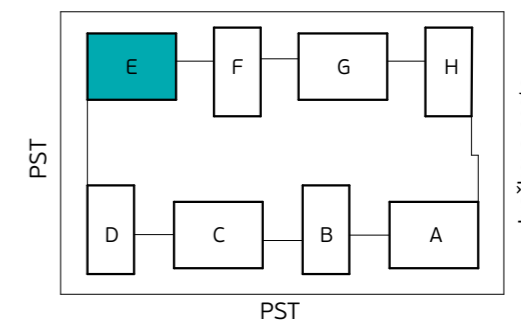

Skica naselja

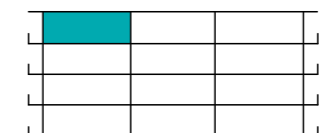

Položaj stanovanja v stavbi - prerez

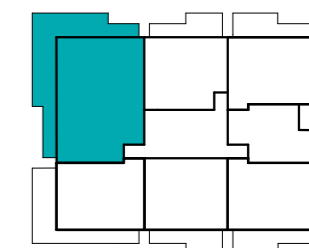

Položaj stanovanja v nadstropju - tloris

STAVBA "E" - 3. NADSTROPJE

STANOVANJE E-3-4

1. PREDPROSTOR	7.9 m ²
2. BIVALNI PROSTOR	54.6 m ²
3. SPALNICA	18.5 m ²
4. KABINET 1	12.2 m ²
5. KABINET 2	13.1 m ²
6. KOPALNICA 1	5.6 m ²
7. KOPALNICA 2	4.3 m ²
8. WC IN UTILITY	3.7 m ²

STANOVANJSKA POVRŠINA 119.9 m²

9. TERASA (NADKRITA)	50.7 m ²
10. SHRAMBA ZA KOLESARJE	5.2 m ²
11. SHRAMBA	5.5 m ²

SKUPNA POVRŠINA 181.3 m²

PARKIRNO MESTO 2 PM

VISEČI VRTOVI 11.7 m²



PRVAHIŠA

Družba za razvoj nepremičninskih projektov

INVESTITOR: **JURČKOVO NASELJE d.o.o.**

PRODAJALEC: **PRVA HIŠA d.o.o.**

Bravničarjeva ulica 13, 1000 Ljubljana

+386 (0)1 292 65 00

info@prvahisa.si

www.jurckovo-naselje.si